

PYLE

OWNER'S MANUAL

PLD-131F



INDASH OR UNDER SEAT MOUNTING
CAR DVD/VCD/CD/MP3 PLAYER WITH FM MODULATOR

www.pyleaudio.com

Welcome!

Thank you for buying this multi-media mobile audio system!

To operate the system correctly, please read the operational manual carefully before using the unit. Keep these instructions and retain this booklet for future reference.

About This Manual

This unit features a number of sophisticated functions ensuring superior operation. This manual will help you understand the functions and operations of the unit. This manual mainly explains **remote control operation**. However, in addition to those functions related with DVD/VCD/CD/MP3 operation that can only be operated by the remote control, there are also functions that can be operated by the buttons provided on the main unit.

CONTENTS

Notes on Installation	4
Precautions	5
Wiring Connection	6
Location of Controls	7
Card Remote Control	8
Basic Operation	10
Playing a DVD	11
Playing a VCD/CD	23
Built-in Radio Frequency Output Mode	25
Playing a MP3	26
Maintenance	27
Install the Unit	28
Specification	29
Simple Troubleshooting Guide	30

Notes on Installation

- ☞ The unit is designed for DC 12V , negative ground operation system only. Before installing the unit, make sure your vehicle is connected to DC 12V negative ground system.
- ☞ Be sure to connect the color coded leads according to the diagram. Incorrect connections may cause the unit to malfunction or damage the vehicle's electrical system.
- ☞ Make sure all the connections are completely correct before turning on your unit.
- ☞ When replacing the fuse(s), the replacement must be of the same amperage as shown on the fuse holder.
- ☞ Do not block vents or radiator panels. Blocking them will cause heat to build up inside and may result in fire.
- ☞ After completing the installation and beginning to play the unit,(including replacing the battery), press **RESET** button on the base with pointed object (such as ball-point pen) to set the unit to initial status.

Precautions

☞ This unit can play the following discs only:

Type of disc	Label on the disc	Recorded material	Size of disc
DVD		Sound and moving pictures	12cm
VCD	 	Sound and moving pictures	12cm
CD		Sound only	12cm
MP3		Sound only	12cm

NOTE: The unit is compatible with VCD 1.0/2.0/3.0 version and DVCD disc.

☞ Do not attempt to modify the unit, modifying the unit may cause an accident.

☞ Stop the vehicle before carrying out any operation that could interfere with your driving.

☞ Do not work in extremely high or low temperature. Be sure the temperature inside the vehicle is between -10°C and $+60^{\circ}\text{C}$ before turning on your unit.

☞ To enjoy optimum sound and images while playing, handle the discs as follows:

—Handle the disc by its edge to keep the disc clean, and do not touch the surface.



—Do not use your CDs with paste residue or ink attached.



—Do not use CDs with labels or stickers attached, which may leave a sticky residue while beginning to peel off.

(Shown as the picture)



—Clean the discs with an optional cleaning cloth. Wipe each disc from the center out.

(Shown as the picture)



Wiring Connection

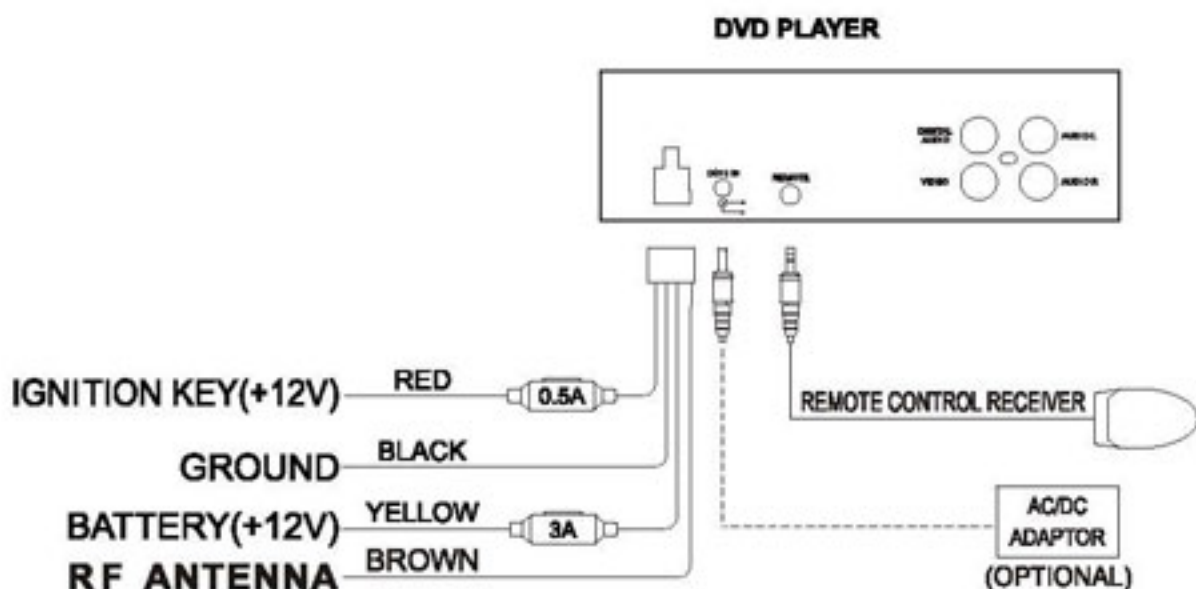

Frequency Setup Button
(Press to turn on the build-in frequency setup.)

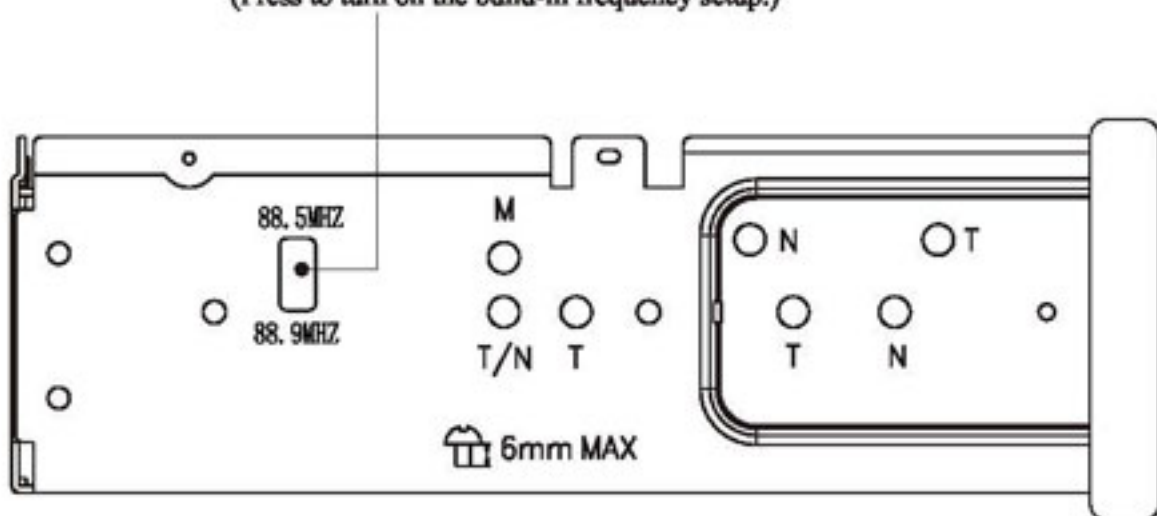

Location of the Controls

Front Panel

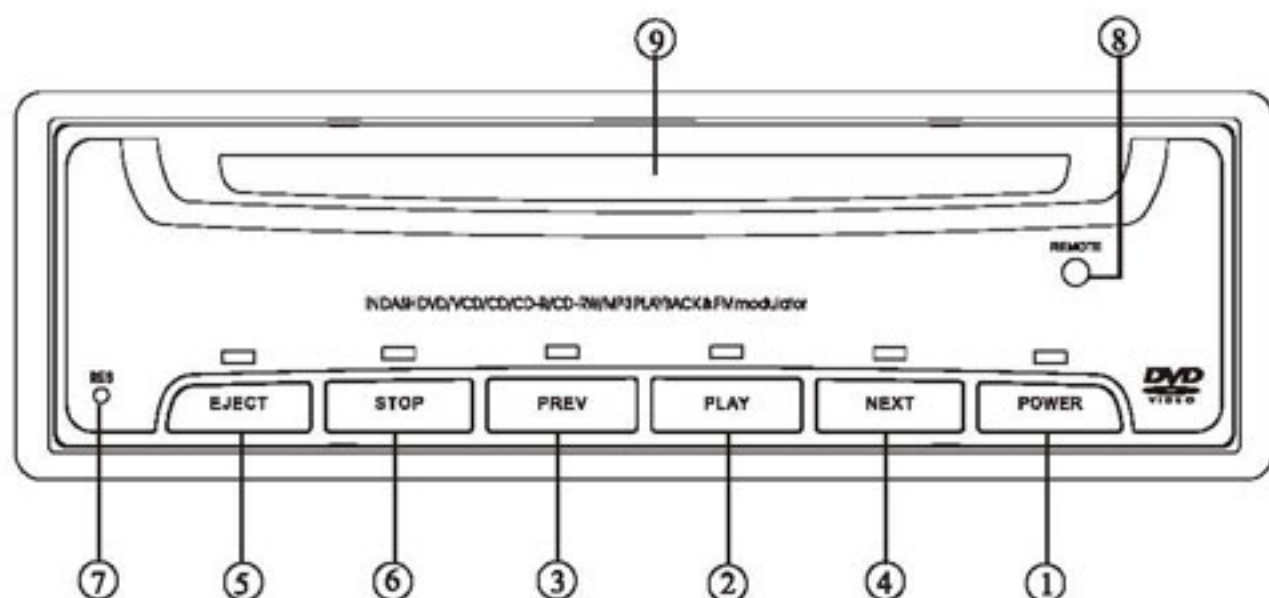

- | | |
|--|--|
| <p>① POWER
Press to turn on or turn off the unit.</p> <p>② PLAY
Press to switch sequentially between playback and pause; during stop mode, you can also press to resume to playback.</p> <p>③ PREV
Press to play the previous track.</p> <p>④ NEXT
Press to play the next track.</p> | <p>⑤ EJECT
Press to eject the disc.</p> <p>⑥ STOP
Press to stop the playback.</p> <p>⑦ RESET
Press to set the unit to initial status.</p> <p>⑧ REMOTE
Remote control receptor.</p> <p>⑨ DISC LOADING SLOT</p> |
|--|--|

OWNER'S MANUAL

- 1 PWR(POWER)**
Press to turn on or turn off the unit.
- 2 SETUP**
During DVD playback mode, press to display system setting menu, user could select some relative constant parameters.
- 3 REPEAT**
Press this button to activate the repeat function.
- 4 ■ STOP**
Press to stop the playback.
- 5 ►|| PLAY/PAUSE**
Press to switch sequentially between playback and pause; during stop mode, press to resume to playback.
- 6 [◀][▶][▲][▼][ENTER]**
In the system setting menu, press [◀][▶][▲][▼] to move cursor upward, downward, leftward or rightward, and then press [ENTER] to execute the entering or the selected item.
- 7 SHIFT**
When shift function is activated, press the buttons which have two function signals on them, the upper function is valid.
- 8 ZOOM and ◀◀**
Press ZOOM to make the picture increase in size;
Press ◀◀ to play the previous track.
- 9 SLOW / ▶|**
Press to slow forward or reverse during playback.
Press ▶| to play the next track.
- 10 ANGLE and ◀◀**
Press ANGLE to change the viewing angle during DVD playback;
Press ◀◀ to perform faster reverse during playback.
- 11 SUBTITLE and ▶▶**
During DVD mode, press SUBTITLE to change the sub-title language.
During playback, press ▶▶ to perform faster forward.
- 12 DISPLAY**
During playback, press DISPLAY, the monitor will display the title, chapter, the elapsed time, and the remained time.
- 13 VOL+/VOL-**
Press to increase or decrease volume level.
- 14 NUMBER BUTTON**
Press to select track, or chapter.
- 15 ▲ EJECT BUTTON**
- 16 MENU**
During DVD mode, press to return to the main page of the root menu.
- 17 TITLE**
During DVD mode, press to return to the main page of the title menu;
during VCD mode, press to activate PBC (Playback Control) function.
- 18 P/N and L/R**
Press P/N to adjust the system, press L/R to select the channel.

Basic Operation

1. Reset the Unit

When operating the unit for the first time or after replacing the car battery, you must reset the unit.

Press **⑦ RES** button on the base with pointed object (such as ball-point pen) to set the unit to initial status.

Note:

- * This function can only be operated on the head unit.
- * Pressing RES button will erase some memorized function.

2. Turn the Unit On/Off

Press **⏻ PWR** button to turn on the unit, press it again to turn off the unit .

Note:

- * Pressing **Ⓚ POWER** button on the head unit performs the same operation.
- * When the unit is turned on, insert a disc, the disc will be played automatically.

3. Volume Control

Press **Ⓜ VOL+** button to increase the sound level and press **Ⓜ VOL-** button to decrease the sound level.

Note:

- * The default volume level is 15. After the unit is off, if the volume level is higher or lower than this default level, it will resume to 15.
- * This function can only be operated on the remote control.

4. Pause the Playback

During playback mode, press **⏸ 5** button to switch between playback and pause; during stop mode, press it to resume to normal playback.

Note:

- * Pressing **Ⓜ** button on the head unit performs the same operation.

5. Shift Function

Press **[7]** button, the monitor will display **[S]**, then press the double function button, the above function is activated. Press SHIFT button again, **[S]** disappears, the other function can be activated.

Note:

- * This function can only be operated on the remote control.

6. Stop the Playback

Press **[4]** **[■]** button to stop playing, press it again to stop completely, press **[▶]** to resume playing.

Note:

- * Pressing **[6]** button on the unit performs the same function

7. Eject a Disc

Press **[EJECT]** on the head unit can eject the disc.

Note:

- * Press **[15]** **[▲]** button on the remote control performs the same operation.

8. Sensor

Infrared Sensor:

Receptor for the card remote commander.

Playing a DVD

1. Slow Motion Playback

During playback, press **[7]**, then press **[9]** to play slow forward or slow reverse. Each pressing, the speed changes as followings:

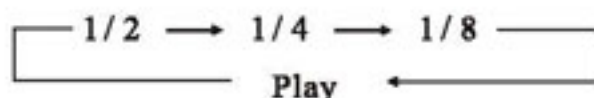

Note:

- * This function can only be operated on the remote control.

2. Fast Forward/Reverse

During playback mode, press **[8]** **[◀]** button to skip reverse to the previous chapter, press **[9]** **[▶]** button to skip forward to the next chapter.

Note:

- * Pressing **[3]** or **[4]** button on the head unit performs the same operation separately.

During playback mode, press **[10]** **[◀◀]** or **[11]** **[▶▶]** button to perform fast reverse or forward separately. Each time the button is pressed, the speed of fast reverse or forward changes as following:

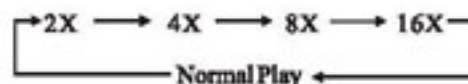

Note:

- * This function can only be operated on the remote control.

3. Menu Selecting

1 During playback mode, press **[16]** **MENU** button can go to the root menu of the disc. TFT shows all the chapters of the disc, you can use **[6]** or **[14]** button to select desired chapter.

2 During playback mode, press **[17]** **TITLE** button can go to the title menu of the disc. TFT shows all the titles of the disc, you can use **[6]** or **[14]** button to select desired title.

Note:

* This function can only be operated on the card remote control.

4. Increase Picture Size

First press **[7]** **SHIFT** button, then press **[8]** **ZOOM** button to increase the size of picture. There are 3 sizes, each press increase the size until the maximum size is reached:

X2 → X3 → X4 → No changing

Note:

* This function can only be operated on the remote control.

5. Repeat Playing

During DVD mode, press **[3]** **REPEAT** button to activate the repeat function. Firstly press it to repeat the current chapter, secondly press it to repeat the current title, thirdly press it to cancel this function.

Note:

* This function can only be operated on the card remote control.

6. System Selector

During playback, press **[18]** **P/N** to adjust the following systems:

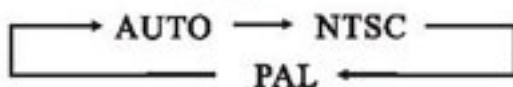

During playback, press **[7]** **SHIFT** then press **[18]** **P/N** to select system, press it again to switch to channel selector.

Note:

* This function can only be operated on the remote control.

7. On-Screen Display

Press **[12]** DISPLAY, the monitor will display the current title, chapter and the elapsed time, the remained time.

Note:

- * This function can only be operated on the remote control.

8. Changing the Subtitle Language (Multi-subtitle)

With DVD featuring multi-subtitle recordings. During playback mode, you can firstly press **[7]** SHIFT button, then press **[11]** SUBTITLE button to switch between subtitle languages.

Selection options switch as follows:

Subtitles 1 — Subtitles 2 — Subtitles OFF

Note:

- * This function can only be operated on the card remote control.
- * This function only operates with DVD featuring multi-subtitle recordings.
- * The number in the "**[2]**" mark on a DVD's package indicates the number of recorded subtitle languages.

9. Changing the View Angle

With DVD featuring multi-angle (scenes shot from multiple angles) recordings, you can firstly press **[7]** SHIFT button, and then press **[10]** ANGLE button to switch among viewing angles during playback.

Selection options switch as follows:

ANGLE 1 — ANGLE 2 — ANGLE 3

Note:

- * This function can only be operated on the card remote control.
- * This function only operates with DVD featuring multi-angle recordings.
- * The "**[3]**" mark on a DVD's package indicates it features multi-angle scenes.
The number in the "**[3]**" mark indicates the number of angles from which scenes were shot.
- * You cannot switch angles during slow motion playback.
- * If you press ANGLE during fast forward/reverse or pause, fast forward/reverse or pause is cancelled and normal playback resumes but the viewing angle does not change.

10. Set Up Menu

During playback mode, press **[2] SETUP** button, the screen will display system setting picture, you can select some relative constant parameters by moving the cursor and using **[6] [◀][▶][▲][▼]** buttons, and then press **[6] ENTER** to execute the selecting item.

Note:

- * This function can only be operated on the card remote control.
- * The selections are preferred options that will be chosen if they are available on a disc. If the disc inserted does not have the preferred option then the disc's own preference will be used.
- * Regarding **SETUP MENU**, please refer to the following pages for more details.
- * Some functions vary depending on the types or formats of the disc.

--General Setup Page--

TV Display

Example showing how to set TV Display mode:

(Press ▲ or ▼)

--General Setup Page--

TVDisplay	Wide
Angle Mark	On
OSD Lang	Eng
Captions	Off
Screen Saver	On

Go To General Setup Page



(Press ► , ▲ or ▼ , then press ENTER)

--General Setup Page--

TVDisplay	Wide	Normal/PS
Angle Mark	On	Normal/LB
OSD Lang	Eng	Wide
Captions	Off	
Screen Saver	On	

Set TV Display mode

Angle Mark

Example showing how to set picture mode:

(Press ▲ or ▼)

--General Setup Page--

TVDisplay	Wide
Angle Mark	On
OSD Lang	Eng
Captions	Off
Screen Saver	On

Go To General Setup Page



(Press ► , ▲ or ▼ , then press ENTER)

--General Setup Page--

TVDisplay	Wide	
Angle Mark	On	On
OSD Lang	Eng	Off
Captions	Off	
Screen Saver	On	

Set Angle Mark

OWNER'S MANUAL

--General Setup Page--

OSD Lang

Example showing how to set language mode:

(Press ▲ or ▼)

--General Setup Page--

TV Display	Wide
Angle Mark	On
OSD Lang	Eng
SPDIF Output	Off
Captions	Off
Screen Saver	On

Go To General Setup Page



(Press ► , ▲ or ▼ , then press ENTER)

--General Setup Page--

TV Display	Wide	
Angle Mark	On	
OSD Lang	Eng	English
SPDIF Output	Off	
Captions	Off	
Screen Saver	On	

Set OSD Language

SPDIF Output

Example showing how to set language mode:

(Press ▲ or ▼)

--General Setup Page--

TV Display	Wide
Angle Mark	On
OSD Lang	Eng
SPDIF Output	Off
Captions	Off
Screen Saver	On

Go To General Setup Page



(Press ► , ▲ or ▼ , then press ENTER)

--General Setup Page--

TV Display	Wide	
Angle Mark	On	
OSD Lang	Eng	
SPDIF Output	Off	SPDIF OFF
Captions	Off	SPDIF CODE
Screen Saver	On	SPDIF/PCM

Set SPDIF Output

--General Setup Page--

Captions

Example showing how to set captions on/off:

(Press ▲ or ▼)

--General Setup Page--

TV Display	Wide
Angle Mark	On
OSD Lang	Eng
SPDIF Output	Off
Captions	Off
Screen Saver	On

Go To General Setup Page



(Press ▶, ▲ or ▼, then press ENTER)

--General Setup Page--

TV Display	Wide	
Angle Mark	On	
OSD Lang	Eng	
SPDIF Output		
Captions	Off	On
Screen Saver	On	Off

Closed Captions

Screen Saver

Example showing how to set Screen Saver on/off:

(Press ▲ or ▼)

--General Setup Page--

TV Display	Wide
Angle Mark	On
OSD Lang	Eng
SPDIF Output	Off
Captions	Off
Screen Saver	On

Go To General Setup Page



(Press ▶, ▲ or ▼, then press ENTER)

--General Setup Page--

TV Display	Wide	
Angle Mark	On	
OSD Lang	Eng	
SPDIF Output	Off	
Captions	Off	
Screen Saver	On	On
		Off

Screen Saver

--Dolby Digital Setup--

Dual Mono

Example showing how to set stereo mode:

(Press ▲ or ▼)

--Dolby Digital Setup--

Dual Mono
Dynamic

Go To Dolby Digital Setup



(Press ►, ▲ or ▼, then press ENTER)

--Dolby Digital Setup--

Dual Mono	Stereo
Dynamic	L-Mono
	R-Mono
	Mix-Mono

Dual Mono (1+1) Setup

Dynamic

Example showing how to set dynamic range compression:

(Press ▲ or ▼)

--Dolby Digital Setup--

Dual Mono
Dynamic

Go To Dolby Digital Setup



(Press ►, ▲ or ▼, then press ENTER)

--Dolby Digital Setup--

Dual Mono	
Dynamic	<ul style="list-style-type: none"> --- FULL --- 3/4 --- 1/2 --- 1/4 --- OFF

Set DRC off

OWNER'S MANUAL

---Preference page---

TV Type

Example showing how to set TV type:

(Press ▲ or ▼)

–Preference Page--

TV Type	Auto
Audio	Eng
Subtitle	Eng
Disc Menu	Eng
Parental	
Password	
Default	

Go To Preference Page



(Press ►, ▲ or ▼, then press ENTER)

–Preference Page--

TV Type	Auto	PAL
Audio	Eng	Auto
Subtitle	Eng	NTSC
Disc Menu	Eng	
Parental		
Password		
Default		

Set TV Standard

Audio

Example showing how to set Audio language:

(Press ▲ or ▼)

–Preference Page--

TV Type	Auto
Audio	Eng
Subtitle	Eng
Disc Menu	Eng
Parental	
Password	
Default	

Go To Preference Page



(Press ►, ▲ or ▼, then press ENTER)

–Preference Page--

TV Type	Auto	
Audio	Eng	English
Subtitle	Eng	
Disc Menu	Eng	
Parental		
Password		
Default		

Preferred Audio Language

OWNER'S MANUAL

---Preference page---

Subtitle

Example showing how to set subtitle language:

(Press ▲ or ▼)

--Preference Page--

TVType	Auto
Audio	Eng
Subtitle	Eng
Disc Menu	Eng
Parental	
Password	
Default	

Go To Preference Page



(Press ►, ▲ or ▼, then press ENTER)

--Preference Page--

TVType	Auto	
Audio	Eng	
Subtitle	Eng	English
Disc Menu	Eng	Off
Parental		
Password		
Default		

Preferred subtitle Language

Disc Menu

Example showing how to set Disc Menu Language:

(Press ▲ or ▼)

--Preference Page--

TVType	Auto
Audio	Eng
Subtitle	Eng
Disc Menu	Eng
Parental	
Password	
Default	

Go To Preference Page



(Press ►, ▲ or ▼, then press ENTER)

--Preference Page--

TVType	Auto	
Audio	Eng	
Subtitle	Eng	
Disc Menu	Eng	English
Parental		
Password		
Default		

Preferred Menu Language

OWNER'S MANUAL

---Preference page---

Parental

Example showing how to set parental control:

(Press ▲ or ▼)

--Preference Page--

TVType	Auto
Audio	Eng
Subtitle	Eng
Disc Menu	Eng
Parental	
Password	
Default	

Go To Preference Page

(Press ►, ▲ or ▼, then press ENTER)

--Preference Page--

TVType	Auto	2	G	▲
Audio	Eng	3	PG	
Subtitle	Eng	4	PG 13	
Disc Menu	Eng	5	PGR	
Parental		6	R	
Password		7	NC 17	
Default		8	Adult	
			Off	

Set Parental Control

Password

Example showing how to set password, and the default password is 8888.

(Press ▲ or ▼)

--Preference Page--

TVType	Auto
Audio	Eng
Subtitle	Eng
Disc Menu	Eng
Parental	
Password	
Default	

Go To Preference Page

(Press ►, ▲ or ▼, then press ENTER)

--Preference Page--

TVType	Auto		
Audio	Eng		
Subtitle	Eng		
Disc Menu	Eng		
Parental			
Password		Change	
Default			

Change Password

OWNER'S MANUAL

---Preferences page--

Default

Example showing how to set load factory setting:

(Press ▲ or ▼)

--Preference Page--

TV Type	Auto
Audio	Eng
Subtitle	Eng
Disc Menu	Eng
Parental	
Password	
Default	

Go To Preference Page



(Press ► , ▲ or ▼ , then press ENTER)



--Preference Page--

TV Type	Auto
Audio	Eng
Subtitle	Eng
Disc Menu	Eng
Parental	
Password	
Default	Reset

Load Factory Setting



Playing a VCD/CD

1. Fast Forward/Reverse

During VCD/CD mode, press **[8]**  button to skip reverse to the previous chapter; press **[9]**  button to skip forward to the next chapter.

Note:

* Pressing **[3]** or **[4]** button on the head unit performs the same operation separately.

During VCD/CD mode, press **[10]**  or **[11]**  button to perform fast reverse or forward separately. Each time the button is pressed, the speed of fast reverse /forward changes as follows:

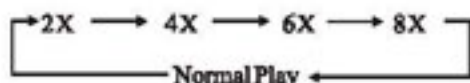

Note:

* This function can only be operated on the card remote control.

2. Repeat Playing

During VCD/CD mode, press **[3]** REPEAT button to activate the repeat function. Firstly press it to repeat the current track, secondly press it to cancel this function.

Note:

* This function can only be operated on the card remote control.

* The default setting is Disc Repeat.

3. On-Screen Display

Press **[12]** DISPLAY, the monitor will display the current title, chapter and the elapsed time, the remained time.

Note:

* This function can only be operated on the card remote control.

4. Playing a VCD/CD

Insert a VCD/CD disc into **[9]** and then disc start the playback.

Note:

* You can eject a disc by pressing EJ button on the head unit or  on the remote control.

5. Number Button

During VCD/CD mode, you can select any track directly by using **[14]** **Number Buttons**. For example, if you need the 15th track, you can firstly press **Button 10+** and then press **Button 5**, the 15th track will be played.

Note:

* This function can only be operated on the card remote control.

6. Slow Motion Playback

During playback, press **[7]**, then press **[9]** to play slow forward or slow reverse. Each pressing, the speed changes as followings:

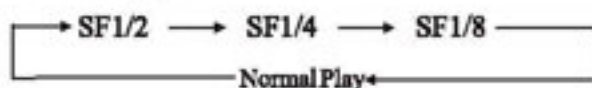

Note:

- * This function can only be operated on the card remote control.

7. Increase Picture Size

During VCD mode, first press **[7]** **SHIFT** button, then press **[8]** **ZOOM** button to increase the size of picture. There are 3 sizes, each press increase the size until the maximum size is reached:

2X → 3X → 4X → OFF

Note:

- * This function can only be operated on the remote control.

8. PBC (Playback Control) Function

During VCD mode, pressing **[17]** **TITLE** button can activate PBC function. TFT shows "PBC ON", and the title menu appears on TFT. You can select tracks by using **[14]** **Number Buttons**. If no number button is pressed during 10s, the first track will be played. Press **TITLE** button again to withdraw PBC function.

Note:

- * This function can only be operated on the card remote control.
- * PBC playing confirms to version 2.0 of VCD disc only.

9. MENU

During VCD mode, when the PBC is on, press **[16]** **MENU** come back to the disc MENU.

Built-in radio frequency output mode

1. Brief function Introduction

Carrier signal of 88.5MHZ or 88.9 MHZ can be switched to radio wave which can be received by FM, the switch in the air is made by the built-in radio frequency output mode of the unit, which tune the audio signal in carrier signal by tuning stereo mode.

2. Operation of the Built-In Radio Frequency Output Mode

- ① Pull out and install the brown antenna, but not install it along the metal surface, or the signal will be affected.
- ② To insure receiving the local stations, tune the frequency in 88.5MHZ or 88.9 MHZ.
- ③ Enjoy the music of DVD, VCD or CD after tuning your radio in 88.5MHZ or 88.9MHZ (stereo frequency modulation radio is the best.)

Maintenance

Replacing the Fuse

Make sure the amperage matches the specified value when replacing the fuses. If the fuse is blown, check the power connection and replace with a new one. If the same problem occurs, it would be subjected to the malfunction. In such cases, please consult to the nearest service dealer.

Warning

Never use the fuse with the rated amperage more than that supplied to your unit, otherwise it will damage the unit.

Replacing the Battery

When the range of the operation of the card remote control becomes short or no functions while operating. Replace the lithium battery with a new button cell (CR2025). Make sure the battery polarity before replace. ①

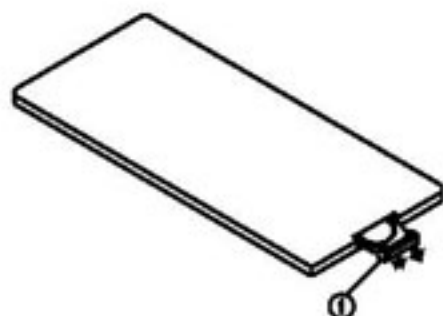

2. Put the button-type battery with mark(+) upward into the Battery Holder.

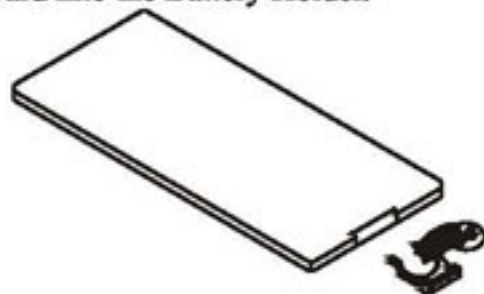

3. Insert the Battery Holder into the Remote Control.



Precautions on Using Lithium Battery

- Always keep the lithium battery beyond children's reach. In case swallowed, see a doctor immediately.
- Cleaning the battery with a dry cloth, to ensure its perfect connected.
- Make sure the proper polarity when loading with the battery.
- To prevent short circuit, do not use metal tweezers to clip the battery.

Warning!

Improper handle with the battery may lead to explosion. It cannot be charged, disassembled or thrown into a fire.

Install the Unit

Installation Method1

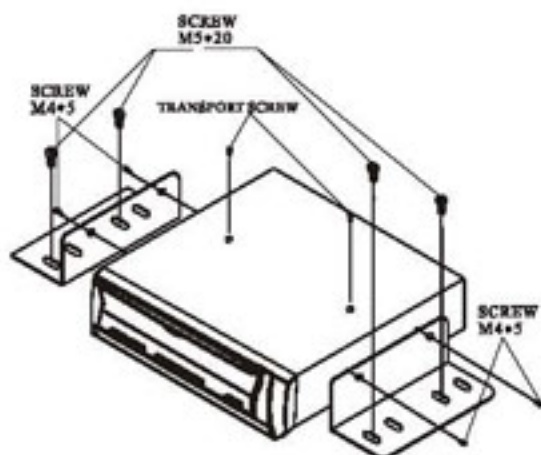

Installation Method2

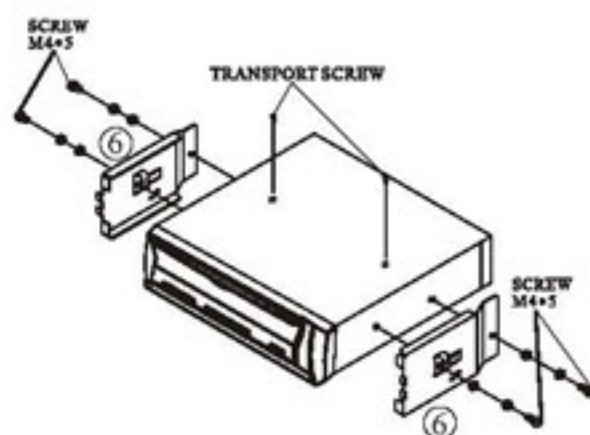

Installation Method2



<p>1</p>	<p>Bend these claws outward for a tight fit, if necessary.</p> <p>2</p>
<p>3</p>	<p>4</p> <p>Front Wall of the Cab</p> <p>To support the unit</p> <p>2</p> <p>3</p>

Detach the Unit (for Installation Method2)

1. Remove the outer trim frame.

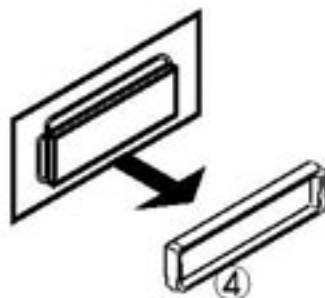

2. Insert the keys supplied with the unit at both sides of the unit as shown in figure until they click. Pulling the keys makes it possible to remove the unit from the dashboard.

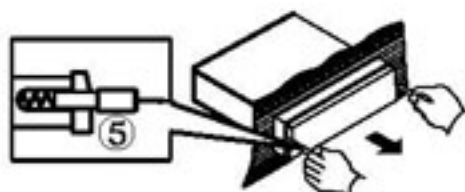

- ① Mounting Sleeve x1 ② Rear Mounting Bolt x1 ③ Harness Rubber x1 or Metallic Lath x 1
 ④ Outer Trim Frame x1 ⑤ Key x2 ⑥ Bracket

Specification

General

Power Requirement	14.4V DC (11-16V allowable)
Load Impedance	10K Ω
Max.Level Output	2V/CH
Dimensions	Approx.168x178x50 mm (d/w/h)
Mounting Dimensions	Approx.150x182x53 mm (d/w/h)
Weight	Approx.1.1kg

Separation	70dB(1KHz)
Distortion	0.1%

DVD Player Section

Number of channel	2 channels
Frequency Response	20Hz—20,000Hz
Dynamic Range	98dB
Signal-to-Noise Ratio	90(JIS)
Wow and Flutter	Less than measurable limit

VCD/CD Player Section

VCD Signal System	PAL/NTSC
Signal-to-noise Ratio	75dB

Note:

Due to continuous product improvement, specifications and design are subject to change without prior notice.

Trouble Shooting

The following checklist can help you to solve some problems when using the unit. Please double check and make sure if the connection and the procedure of the operation are proper before using the checklist below .

Problem	Cause/Solution
No power.	<ul style="list-style-type: none">• Check and make sure whether the fuse is blown, replace with the proper value if necessary.
No function when pressing the button.	<ul style="list-style-type: none">• Press RESET button.
A CDs cannot be loaded.	<ul style="list-style-type: none">• A CDs is loaded in the mechanism.
Sound skips.	<ul style="list-style-type: none">• The CDs is dirty or damaged.
No Images.	<ul style="list-style-type: none">• The Video line from main unit to the TV is not connected properly.
Images skip.	<ul style="list-style-type: none">• Improper setting of the color system. Set the color system to "PAL" or "NTSC" according to the connected television.

Note:

If any of the problem persists after checklist had been made, consult your nearest service dealer. Never attempt to disassemble your unit by yourself.